

PRICE



CSABA TOUCH FREE HAND SANITIZER



TOUCH FREE HAND SANITIZER
STAND

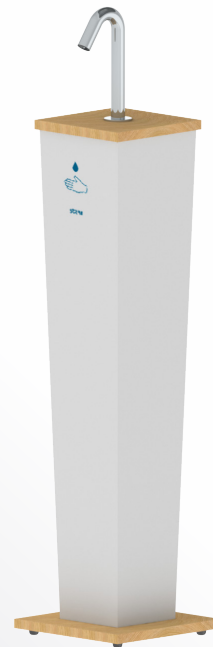

TOUCH FREE HAND SANITIZER
PILLAR

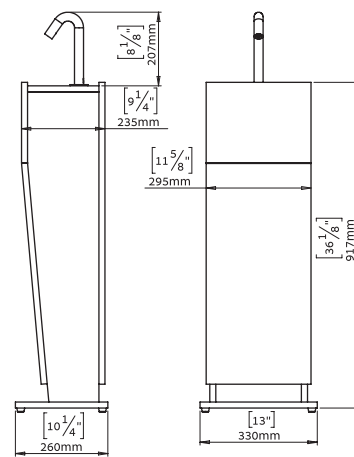

Ref: 281000

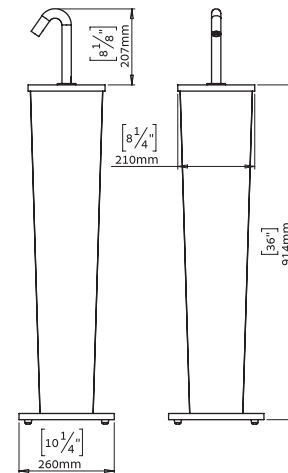

Ref: 281100

| | |
|------------------------|---------------------------------------|
| Minimum order quantity | 10% discount for 16 units and above |
| Packaging information | 96x28x35 14 kg - 1 unit |
| Shipping information | 120x100x157 240kg 1 pallet = 16 units |

Csaba Touch Free Hand Sanitizer Stand - 1.6

| Drawing | Description | Power supply | Version | Ordering code |
|---------|--|---|-------------|---------------|
| | Features a chrome plated full brass spout with concealed hidden sensor. 1.6 US gallon (6 L) tank. Podium with front opening door. | Battery box for 6 x DD batteries (batteries not supplied) | Battery | 281000CS6B |
| | | 12V Universal transformer (plugs for US/UK/EU/AU). | Transformer | 281000CS6E |

Csaba Touch Free Hand Sanitizer Stand - 1L

| Drawing | Description | Power supply | Version | Ordering code |
|---------|---|---|-------------|---------------|
| | Features a chrome plated full brass spout with concealed hidden sensor. 0.26 US gallon (1 L) bottle. Podium with side opening door and internal shelf. | Battery box for 6 x DD batteries (batteries not supplied) | Battery | 281000CS1B |
| | | 12V Universal transformer (plugs for US/UK/EU/AU). | Transformer | 281000CS1E |

Csaba Touch Free Hand Sanitizer Pillar - 1L

| Drawing | Description | Power supply | Version | Ordering code |
|---------|---|---|-------------|---------------|
| | Features a chrome plated full brass spout with concealed hidden sensor. 0.26 US gallon (1 L) bottle. Podium with back opening door and internal shelf. | Battery box for 6 x DD batteries (batteries not supplied) | Battery | 281100CSB |
| | | 12V Universal transformer (plugs for US/UK/EU/AU). | Transformer | 281100CSE |

Accessories & Options

| Product | Ordering code | Description |
|----------------|---------------|---|
| Remote control | 07100008 | Included on selected models |
| Tray | 03300048 | For easy cleaning |
| Power source | DP | Both power options in one product |
| Lockable door | LD | For locations with risk of tampering. Available for 6L models only. |

CLASSIC TOUCH FREE HAND SANITIZER

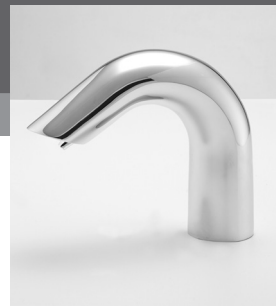

ELITE TOUCH FREE HAND SANITIZER

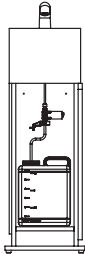

Classic Touch Free Hand Sanitizer Stand - 1.6

| Drawing | Description | Power supply | Version | Ordering code |
|---|--|---|-------------|---------------|
|  | Robust one piece chrome plated brass construction with concealed hidden sensor. 1.6 US gallon (6 L) tank. Podium with front opening door | Battery box for 6 x DD batteries (batteries not supplied) | Battery | 281000CL6B |
| | | 12V Universal transformer (plugs for US/UK/EU/AU). | Transformer | 281000CL6E |

Classic Touch Free Hand Sanitizer Stand - 1L

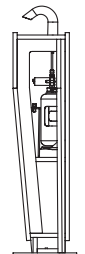
| Drawing | Description | Power supply | Version | Ordering code |
|--|--|---|-------------|---------------|
|  | Robust one piece chrome plated brass construction with concealed hidden sensor. 0.26 US gallon (1 L) bottle. Podium with side opening door and internal shelf. | Battery box for 6 x DD batteries (batteries not supplied) | Battery | 281000CL1B |
| | | 12V Universal transformer (plugs for US/UK/EU/AU). | Transformer | 281000CL1E |

Classic Touch Free Hand Sanitizer Pillar - 1L

| Drawing | Description | Power supply | Version | Ordering code |
|---|--|---|-------------|---------------|
|  | Robust one piece chrome plated brass construction with concealed hidden sensor. 0.26 US gallon (1 L) bottle. Podium with back opening door and internal shelf. | Battery box for 6 x DD batteries (batteries not supplied) | Battery | 281100CLB |
| | | 12V Universal transformer (plugs for US/UK/EU/AU). | Transformer | 281100CLE |

Accessories & Options

| Product | Ordering code | Description |
|----------------|---------------|---|
| Remote control | 07100008 | Included on selected models |
| Tray | 03300048 | For easy cleaning |
| Power source | DP | Both power options in one product |
| Lockable door | LD | For locations with risk of tampering. Available for 6L models only. |

Elite Touch Free Hand Sanitizer Stand - 1.6

| Drawing | Description | Power supply | Version | Ordering code |
|---|---|---|-------------|---------------|
|  | Features an antibacterial, anticorrosion and durable Stainless Steel AISI 316 body. Includes remote control to select the dosage and for automatic refill. 1.6 US gallon (6 L) tank. Podium with front opening door. Remote control included. | Battery box for 6 x DD batteries (batteries not supplied) | Battery | 281000EL6B |
| | | 12V Universal transformer (plugs for US/UK/EU/AU). | Transformer | 281000EL6E |

Elite Touch Free Hand Sanitizer Stand - 1L

| Drawing | Description | Power supply | Version | Ordering code |
|--|--|---|-------------|---------------|
|  | Features an antibacterial, anticorrosion and durable Stainless Steel AISI 316 body. Includes remote control to select the dosage and for automatic refill. 0.26 US gallon (1 L) bottle. Podium with side opening door and internal shelf. Remote control included. | Battery box for 6 x DD batteries (batteries not supplied) | Battery | 281000EL1B |
| | | 12V Universal transformer (plugs for US/UK/EU/AU). | Transformer | 281000EL1E |

Elite Touch Free Hand Sanitizer Pillar - 1L

| Drawing | Description | Power supply | Version | Ordering code |
|---|--|---|-------------|---------------|
|  | Features an antibacterial, anticorrosion and durable Stainless Steel AISI 316 body. Includes remote control to select the dosage and for automatic refill. 0.26 US gallon (1 L) bottle. Podium with back opening door and internal shelf. Remote control included. | Battery box for 6 x DD batteries (batteries not supplied) | Battery | 281100ELB |
| | | 12V Universal transformer (plugs for US/UK/EU/AU). | Transformer | 281100ELE |

Accessories & Options

| Product | Ordering code | Description |
|----------------|---------------|---|
| Remote control | 07100008 | Included on this premium model |
| Tray | 03300048 | For easy cleaning |
| Power source | DP | Both power options in one product |
| Lockable door | LD | For locations with risk of tampering. Available for 6L models only. |



05/2020

STERN ENGINEERING LTD.

777 Passaic Avenue Clifton NJ, 07012
Tel: +1-973 773 8011 Toll Free: 1-800-4364410
info@sternfaucets.com

www.sternfaucets.com
www.sternfaucets.es