

## CSABA SOAP DISPENSER

### TOUCH-FREE DECK MOUNTED SOAP DISPENSER

#### SPECIFICATIONS

Touch free electronic soap dispenser for deck mounted installations. Chrome plated body, other finishes available. Activated by concealed sensor built into the spout. Includes a 1 liter soap bottle and bottle support. Optional for remote installation: extension cable and longer piping. The following functions can be performed by using Stern remote control: soap quantity selection, refill the soap tank, temporary off, coming back to factory settings

#### OPERATION

Closing automatically without dripping, the Csaba touch free soap dispenser helps ensure hygiene and cleanliness in commercial restrooms. Combined with the Csaba touch free electronic faucet, it creates a complete germ-free and automated environment.

#### APPLICATION

The soap dispenser is activated automatically when the users bring their hands within the sensor range and stops when the users remove their hands.

#### PRODUCT AT A GLANCE

Installation	Deck mounted. Regular installation with the bottle below the lavatory or remote installation with bottle support kit to be secured to the wall.
Power Supply	<ul style="list-style-type: none"> <li>Battery box for six (6) DD batteries</li> <li>12V transformer</li> </ul>
Soap	1 Liter soap bottle. This soap dispenser includes a peristaltic pump that allows the use of any kind of liquid soap, detergent or antibacterial gel.
Soap Dose	Factory setting for 0.7 to 0.9 cc depending on the selected soap. The soap quantity can be changed using the soap dispenser's remote control.
Refill	Easy to use refill button in order the soap will start to come out of the soap dispenser spout. This function can also be performed with the remote control.

#### ORDERING INFORMATION

MODEL	CODE
Csaba Soap Dispenser E	233101
Csaba Soap Dispenser B	233111

#### OPTIONS

OPTION	CODE
Remote control	07100008
Matching battery-powered faucet	233000
Matching transformer-powered faucet	233010
6-pack: 6 soap dispensers and a remote control	Upon request
Multifeed system	Upon request

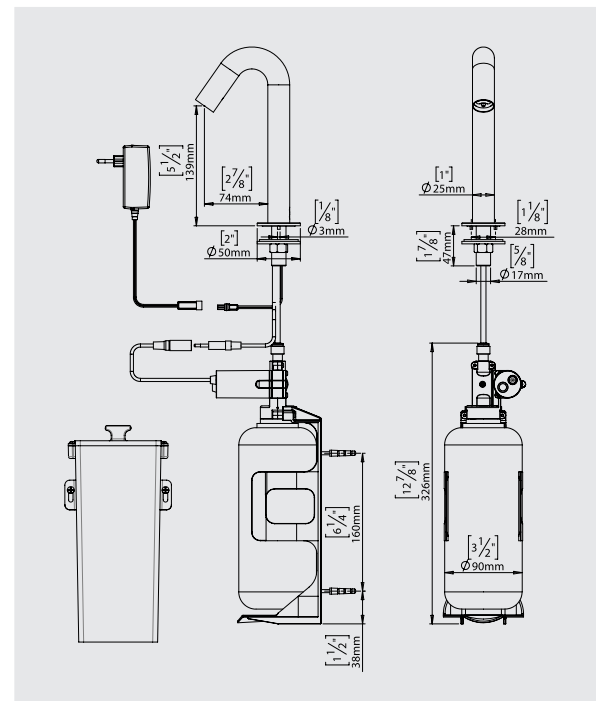

**stern**  
STERN ENGINEERING LTD.

#### ADVANTAGES



MAXIMUM SAVINGS



GERM FREE



PRECISE AMOUNT



CHANGE SETTINGS



SOAP AND WATER



CLOGGING FREE



EASY TO INSTALL

777 Passaic Avenue  
Clifton NJ, 07012  
USA: sternusa@sternfaucets.com  
International: info@sternfaucets.com  
Toll Free: 1-800-4364410  
www.sternfaucets.com